

ALUMINUM WALL MOUNTED BRACKET STAND FOR AIR CONDITIONING UNIT

1- THIS EQUIPMENT UNIT STAND SYSTEM SHOWN ON THIS PRODUCT EVALUATION DOCUMENT (P.E.D) HAS BEEN VERIFIED FOR CODE COMPLIANCE IN ACCORDANCE WITH THE 2023 (8th EDITION) OF THE FLORIDA BUILDING CODE AND CHAPTER 20 OF SAME, FOR USE WITHIN THE HIGH VELOCITY HURRICANE ZONE (HVHZ) OR OUT OF IT. DESIGN PRESSURES CALCULATED FOR USE WITH THIS SYSTEM SHALL BE DETERMINED SEPARATELY ON A JOB-SPECIFIC BASIS IN ACCORDANCE WITH THE GOVERNING CODE USING ASD METHODOLOGY, IN ACCORDANCE WITH ASCE 7-22 AND SECTIONS 1609.1.1, 1616.1.1, 1620.1, 1620.2, 1620.3, 1620.6 & 1620.7 OF THE FLORIDA BUILDING CODE, AND SHALL BE LESS THAN OR EQUAL TO THE LATERAL AND UPLIFT DESIGN PRESSURE CAPACITY VALUES LISTED HEREIN FOR ANY ASSEMBLY AS SHOWN:

MAX LATERAL WIND LOAD: +90,-90psf
MAX UPLIFT WIND LOAD: -90 psf

2- THE ARCHITECT/ENGINEER OF RECORD FOR THE EXISTING STRUCTURE THAT WILL SUPPORT THESE ALUMINUM STANDS SHALL BE RESPONSIBLE FOR ITS INTEGRITY AND SHALL VERIFY THE ADEQUACY OF THE EXISTING STRUCTURE TO WITHSTAND THE SUPERIMPOSED LOADS (ASD) - REF "REACTION SCHEDULE" INDICATED ON THIS SHEET, WHERE REACTION FORCES ARE LISTED FOR USE WITH EXISTING STRUCTURE. DESIGN PROFESSIONAL OF RECORD SHALL VERIFY APPLICABILITY AND/OR ADDITIONAL FACTORS FOR USE WITH EXISTING STRUCTURE VERIFICATION.

3- CONNECTION (TIE DOWN) OF UNIT TO BRACKET STAND IS NOT INCLUDED, AND SHALL BE PERFORMED IN A JOB BY JOB BASIS.

4- STAND SHALL BE INSTALLED WITH MINIMUM CLEAR HEIGHT AS SPECIFIED ON THIS P.E.D.

5- VIBRATION ISOLATOR PADS SHALL BE PROVIDED BY OTHERS BETWEEN UNITS & STAND.

6- STRUCTURAL ADEQUACY OF EQUIPMENT FOR WIND RESISTANCE IS NOT PART OF THIS DOCUMENT AND MUST BE VERIFIED SEPARATELY.

7- ELECTRICAL GROUND, WHEN REQUIRED, TO BE DESIGNED & INSTALLED BY OTHERS. ALL MECHANICAL SPECIFICATIONS (CLEAR SPACE, TONNAGE, ETC.) SHALL BE AS PER MANUFACTURER RECOMMENDATIONS AND ARE THE EXPRESS RESPONSIBILITY OF THE CONTRACTOR.

8- MAXIMUM DIMENSIONS AND WEIGHT OF MECHANICAL UNITS SHALL CONFORM TO SPECIFICATIONS STATED HEREIN, SEE SHEET 3.

9- ALL ANCHORS, SCREWS & BOLTS TO WALL SHALL BE AS SPECIFIED ON THIS DRAWING, AND SHALL COMPLY WITH SECTION 2411.3.3.4 OF THE FLORIDA BUILDING CODE.

10- ALL ALUMINUM EXTRUSIONS SHALL BE 6061-T6 ALLOY & TEMPER, UNLESS NOTED OTHERWISE. WELDING SHALL BE PERFORMED IN ACCORDANCE WITH AWS D 1.2 REQUIREMENTS, USING 5356 FILLER ALLOYS.

11- ALL EXISTING CONCRETE SUBSTRATE SHALL HAVE MINIMUM COMPRESSIVE STRENGTH OF 3000 PSI. ALL CONCRETE BLOCK WALL SHALL HAVE $f_m = 1500$ psi AND TO BE ASTM C-90 COMPLIANT. ALL WOOD STUDS AT WOOD FRAME WALLS SHALL BE HAVE A MIN. $G=0.55$ DENSITY.

12- ALL ALUMINUM EXTRUSIONS IN CONTACT WITH DISSIMILAR MATERIALS SHALL COMPLY WITH SECTION III-6 OF THE 2020 ALUMINUM DESIGN MANUAL.

13- ENGINEER SEAL AFFIXED HERETO VALIDATE STRUCTURAL DESIGN AS SHOWN ONLY. USE OF THIS SPECIFICATION BY CONTRACTOR, et. al. INDEMNIFIES & SAVES HARMLESS THIS ENGINEER FOR ALL COST & DAMAGES INCLUDING LEGAL FEES & APPELLATE FEES RESULTING FROM MATERIAL FABRICATION, SYSTEM ERECTION, CONSTRUCTION PRACTICES BEYOND THAT WHICH IS CALLED FOR BY LOCAL, STATE, & FEDERAL CODES & FROM DEVIATIONS OF THIS PLAN. EXCEPT AS EXPRESSLY PROVIDED HEREIN, NO ADDITIONAL CERTIFICATIONS OR AFFIRMATIONS ARE INTENDED ON THIS DOCUMENT.

THIS DRAWING SHALL ONLY BE USED TO OBTAIN PERMITS IN THE STATE OF FLORIDA

14- WATER-TIGHTNESS OF EXISTING HOST SUBSTRATE SHALL BE THE FULL RESPONSIBILITY OF THE INSTALLING CONTRACTOR. CONTRACTOR SHALL ENSURE THAT ANY REMOVED OR ALTERED WATERPROOFING MEMBRANE IS RESTORED AFTER FABRICATION AND INSTALLATION OF STRUCTURE PROPOSED HEREIN. THIS ENGINEER SHALL NOT BE RESPONSIBLE FOR ANY WATERPROOFING OR LEAKAGE ISSUES WHICH WAY OCCUR AS WATER-TIGHTNESS SHALL BE THE FULL RESPONSIBILITY OF THE INSTALLING CONTRACTOR.

15- (a) THIS P.E.D. (PRODUCT EVALUATION DOCUMENT) PREPARED BY THIS ENGINEER IS GENERIC AND DOES NOT PROVIDE INFORMATION FOR A SITE SPECIFIC PROJECT; i.e. WHERE THE SITE CONDITIONS DEVIATE FROM THE P.E.D.

(b) CONTRACTOR TO BE RESPONSIBLE FOR THE SELECTION, PURCHASE AND INSTALLATION INCLUDING LIFE SAFETY OF THIS PRODUCT, BASED ON THIS P.E.D., PROVIDED HE/SHE DOES NOT DEVIATE FROM THE CONDITIONS DETAILED ON THIS DOCUMENT. CONSTRUCTION SAFETY AT SITE IS THE CONTRACTOR'S RESPONSIBILITY.

(c) THIS P.E.D. WILL BE CONSIDERED INVALID IF ALTERED BY ANY MEANS.

(d) SITE SPECIFIC PROJECTS SHALL BE PREPARED BY A FLORIDA REGISTERED ENGINEER OR ARCHITECT WHICH WILL BECOME THE ENGINEER OF RECORD (E.O.R.) FOR THE PROJECT AND WHO WILL BE RESPONSIBLE FOR THE PROPER USE OF THE P.E.D.

(e) ORIGINAL P.E.D. SHALL BEAR THE DATE AND ORIGINAL SEAL AND SIGNATURE OF THE PROFESSIONAL ENGINEER OF RECORD THAT PREPARED IT.

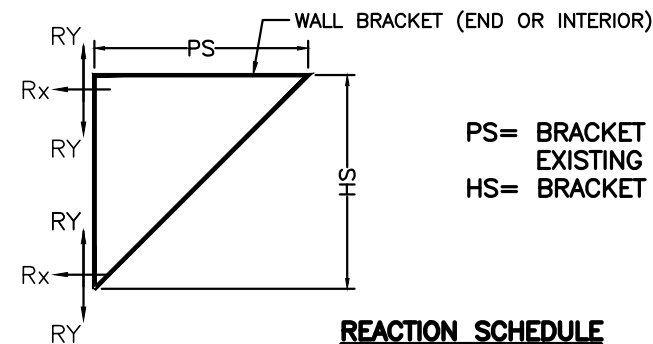

REACTION SCHEDULE

		BRACKET DIMENSIONS			
PS	HS	END BRACKETS*		INTERIOR BRACKETS**	
		Rx(Lbs.)	Ry(Lbs.)	Rx(Lbs.)	Ry(Lbs.)
18	18	65	117	336	261
24	24	194	201	336	261
30	30	205	202	336	261
24	18	255	197	336	261
36	30	190	170	336	261
48	36	660	476	336	261
36	36	190	170	336	261
40	40	660	476	336	261

* SEE SHEET 3,6
 ** SEE SHEET 4,6

SHEET #	INDEX DESCRIPTION
1	GENERAL NOTES AND INDEX
2	BILL OF MATERIALS AND COMPONENTS
3	ASSEMBLY DETAILS FOR WALL MOUNTED BRACKET STAND W/ ONLY (2) END BRACKETS
4	ASSEMBLY DETAILS FOR WALL MOUNTED BRACKET STAND W/ UP TO (3) INTERIOR BRACKETS
5	EQUIPMENT UNIT TIE DOWN TO BRACKET DETAILS
6	WALL BRACKET ANCHORAGE TO EXISTING STRUCTURE

FLORIDA BUILDING CODE (High and Non High Velocity Hurricane Zone)

DRAWN BY: W.H
 01/08/2024
 DATE:

23-246
 DRAWING No

ALUMINUM WALL MOUNTED BRACKET
 STAND FOR AIR CONDITIONING UNIT

F&L ALUMINUM PARTS, INC.
 2087 N. POWERLINE RD. SUITE #1
 POMPANO BEACH, FL. 33069

TITTECO INC.
 TITTECO TESTING & ENGINEERING COMPANY
 6355 N.W. 36th St. Ste. 305 VIRGINIA GARDENS, FL 33166
 Phone: (305)871-1530 Fax: (305)871-1531
 e-mail: titteco@aol.com
 CA-0006719
 WALTER A. TILLIT JR. P.E.
 FLORIDA Lic. # 44167

© 2024 TITTECO INC.

REV. No. DATE DESCRIPTION
 1 - - -
 2 - - -
 3 - - -
 4 - - -

SHEET 1 OF 6

P.E. SEAL/SIGNATURE/DATE

BILL OF MATERIALS

COMPONENT No.	DESCRIPTION	DIMENSIONS	MATERIAL	MANUFACTURER	NOTES
①	BRACING FRAME ANGLE FOR WALL MOUNTING BRACKETS	2.00" X 2.00" X 1/8" X VARIES	6063-T5 ALUM. ALLOY	-	BOLTED W/ ③ TO ② @ WALL BRACKET
②	FRAME ANGLE FOR WALL MOUNTING BRACKETS	3.00 "x 3.00" x 1/8" x VARIES	6061-T6 ALUM. ALLOY	-	WELDED FRAME FOR WALL BRACKET
③	FASTENERS FOR ① & ②	3/8"φ-16	ASTM A-307 GALV. STEEL BOLTS	-	USE FOR ① CONNECTION TO ② SEE DETAILS
④	TIE DOWN STRAP	1.00" X 0.030"	ASTM A-653 GRADE 33, G-90 GALV. STEEL	-	UNIT TIE DOWN TO ② ACROSS BRACKETS SEE DETAILS
⑤	TIE DOWN CLIP	2" x 1" x 1/8" x 0'-2" ALUM.	6063-T5 ALUM. ALLOY	-	UNIT TIE DOWN TO ② PERPENDICULAR TO ④ SEE DETAILS
⑥	FASTENERS FOR ④ & ⑤	1/4"φ-14 X 3/4" TEK-SCREW	AISI 401 STAINLESS STEEL	ITW/BUILDEX	SEE DETAILS SHEET 5
⑦	SCREW BOLT FOR ② INTO EXISTING POURED CONCRETE OR GROUTED FILLED CONCRETE BLOCK WALL (REQ'D)	3/8"φ	CASE HARDENED LOW CARBON STEEL, Fy=74 Ksi, Fu=92.5 Ksi MECHANICALLY GALVANIZED ZINC PLATED PER ASTM B 695 CLASS 55	DEWALT	3 1/2" MIN, EMBEDMENT INTO EXISTING POURED CONCRETE OR GROUTED FILLED CONCRETE BLOCK WALL W/2,000 psi GROUT W/4" MIN. EDGE DISTANCE. GROUTING MUST BE PERFORMED 8" ALL AROUND ⑦ SEE DETAILS SHEETS 3, 4 ,6
⑧	LAG SCREW FOR ② INTO EXISTING WOOD STRUCTURE	3/8"φ	GALVANIZED STEEL Fy=45000psi	-	3 1/4" MIN, PENETRATION INTO EXISTING WOOD STRUCTURE W/1 1/2" MIN. EDGE DISTANCE SEE DETAILS SHEETS 3, 4, 6
⑨	ELCO TAP FLEX FOR ② INTO EXISTING STEEL STRUCTURE	3/8"φ X 1 1/2"	ASTM A 449 (Fu=120 Ksi) W/ SILVER STALGARD SUB COATING	ELCO CONSTRUCTION PRODUCTS	W/3/4" MIN. EDGE DISTANCE. SEE DETAILS AND MIN. 3 THREADS PASSED BEYOND SUBSTRUCTURE
⑩	THRU BOLT W/ BACKUP PLATE FOR OPTIONAL HOLLOW CONCRETE BLOCK WALL INSTALLATION	1/2"φ X 10" LONG (MIN.)	ASTM A-36 GALV. STEEL OR A.I.S.I 304 SS	-	USE AS OPTIONAL INSTALLATION FOR HOLLOW BLOCK WALLS W/ 3/8"THICK X 8" X 8"ASTM A-36 GALV. STL. BACK UP PLATE AT REAR OF WALL

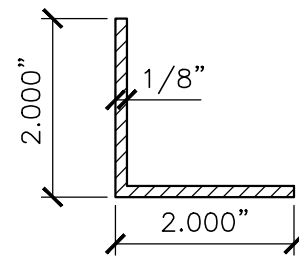

① BRACING FRAME ANGLE FOR WALL MOUNTING BRACKET

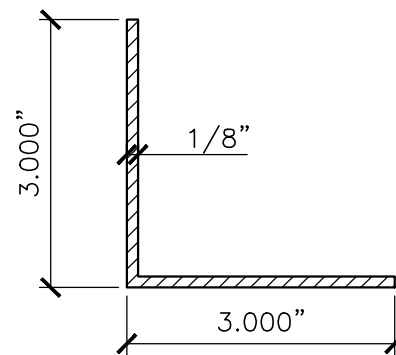

② FRAME ANGLE FOR WALL MOUNTING BRACKET

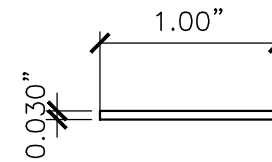

④ TIE DOWN STRAP

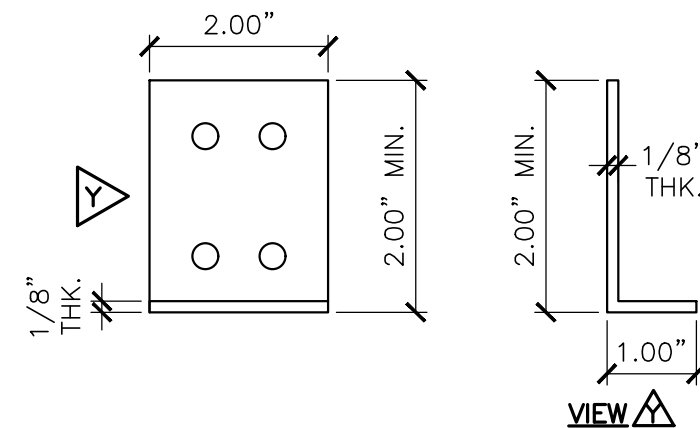

⑤ TIE DOWN CLIPS

COMPONENTS

SCALE: N.T.S

FLORIDA BUILDING CODE (High and Non High Velocity Hurricane Zone)

ALUMINUM WALL MOUNTED BRACKET
STAND FOR AIR CONDITIONING UNIT

F&L ALUMINUM PARTS, INC.
2087 N. POWERLINE RD. SUITE #1
POMPANO BEACH, FL. 33069

© 2024 TILTECO INC.

TILTECO INC.
TILLIT TESTING & ENGINEERING COMPANY
6355 N.W. 36th St. Ste. 305 VIRGINIA GARDENS, FL 33166
Phone : (305)871-1530 . Fax : (305)871-1531
e-mail: tilteco@aol.com

WALTER A. TILLIT JR. P.E.
FLORIDA Lic. # 44167

DRAWN BY:
W.H

DATE
01/08/2024

DRAWING No
23-246

SHEET 2 OF 6

P.E. SEAL/SIGNATURE/DATE

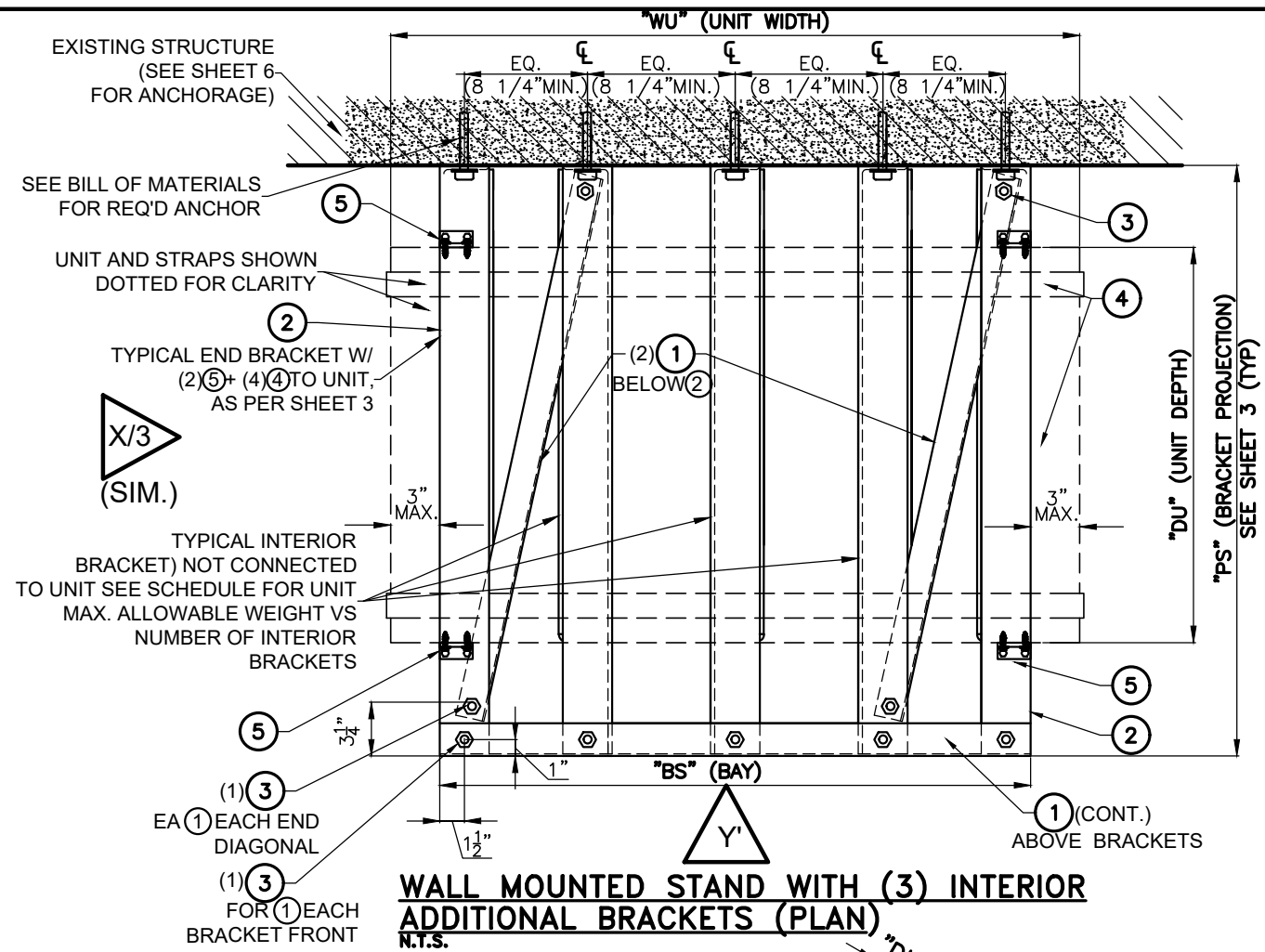

WALL MOUNTED STAND WITH (3) INTERIOR ADDITIONAL BRACKETS (PLAN)
N.T.S.

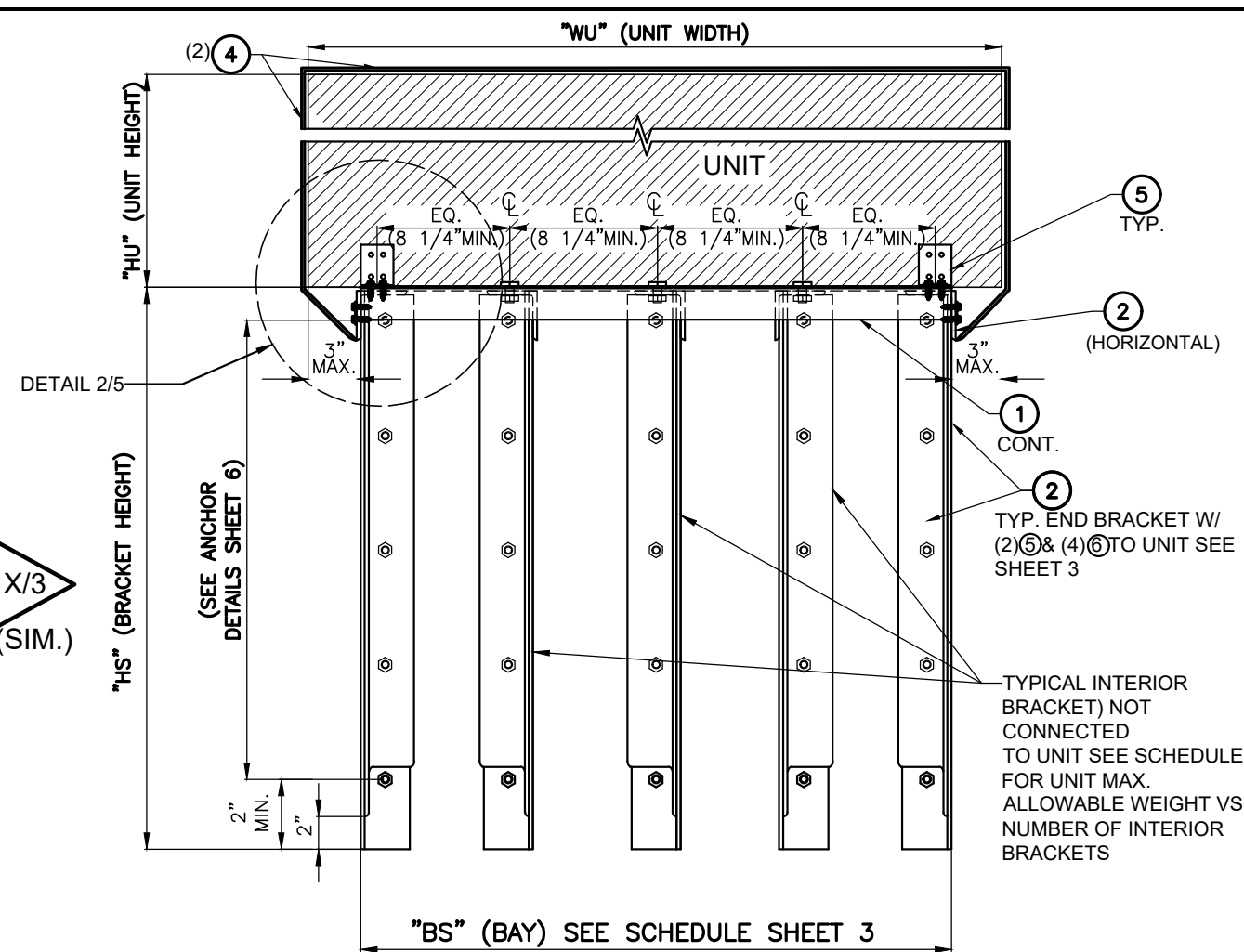

WALL MOUNTED STAND WITH (3) INTERIOR ADDITIONAL BRACKETS (FRONT ELEV.)
N.T.S.

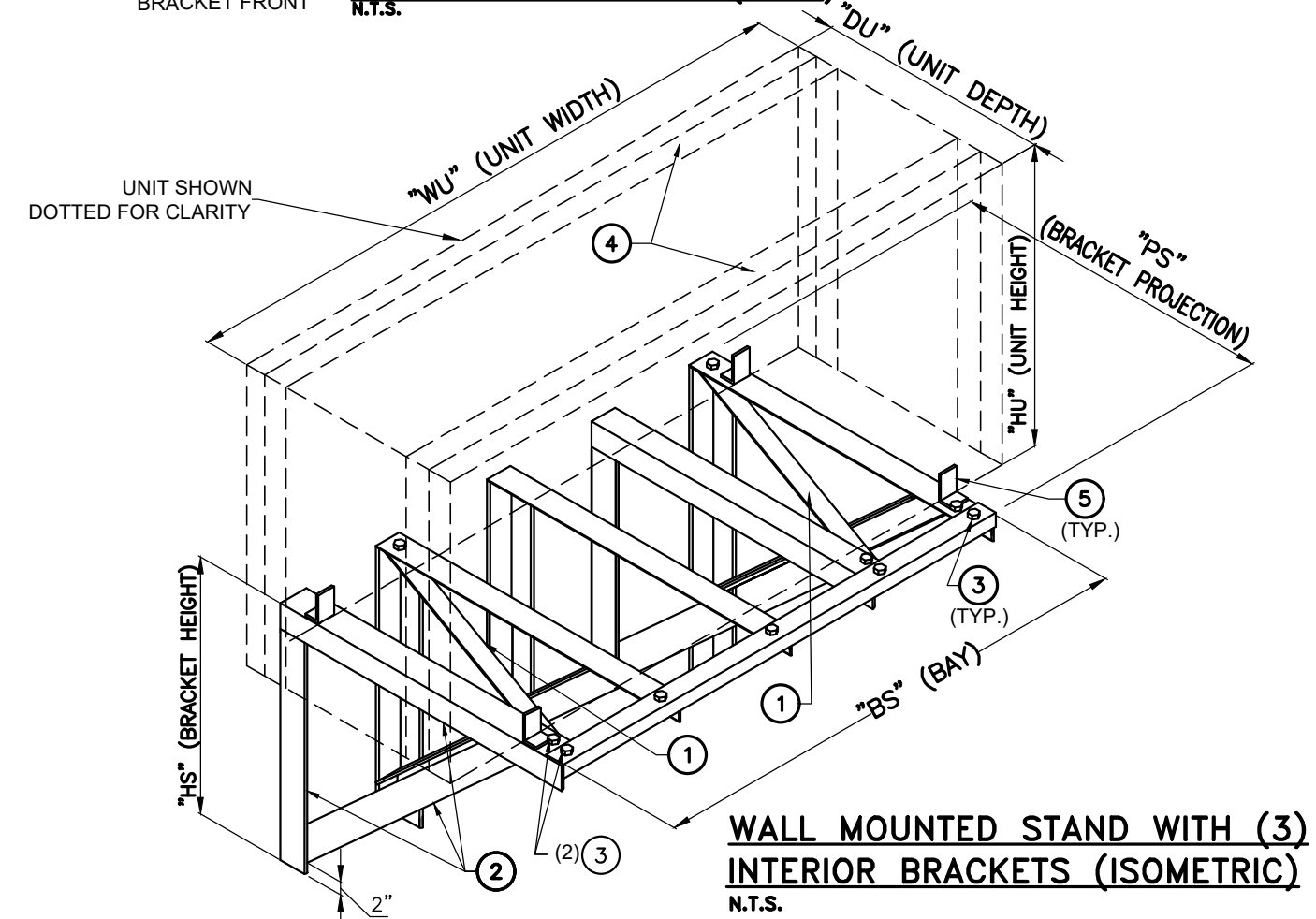

WALL MOUNTED STAND WITH (3) INTERIOR BRACKETS (ISOMETRIC)
N.T.S.

TYPICAL WALL MOUNTED BRACKET STANDS WITH (3) INTERIOR ADDITIONAL BRACKETS TO SUPPORT UNIT WEIGHTS LARGER THAN SHOWN ON SCHEDULE ON SHEET 3 (SEE SHEET 3 FOR END BRACKET STANDS)

(SEE SHEET 4 FOR # OF INTERIOR BRACKETS VS WEIGHT SCHEDULE AND NOTES)

FLORIDA BUILDING CODE (High and Non High Velocity Hurricane Zone)
DRAWN BY: W.H
DATE: 01/08/2024
23-246
DRAWING No

ALUMINUM WALL MOUNTED BRACKET STAND FOR AIR CONDITIONING UNIT
F&L ALUMINUM PARTS, INC.
2087 N. POWERLINE RD. SUITE #1
POMPAHO BEACH, FL. 33069

© 2024 TILTECO INC.
TILTECO INC.
TILLIT TESTING & ENGINEERING COMPANY
6355 N.W. 36th St. Ste. 305 VIRGINIA GARDENS, FL 33166
Phone: (305)871-1530 Fax: (305)871-1531
e-mail: tilteco@aol.com
CA-0006719
WALTER A. TILLIT Jr. P.E.
FLORIDA Lic. # 44167

REV. NO. 1 2 3 4
DATE
DESCRIPTION
DATE
DESCRIPTION
DATE
DESCRIPTION
DATE
DESCRIPTION

P.E. SEAL/SIGNATURE/DATE

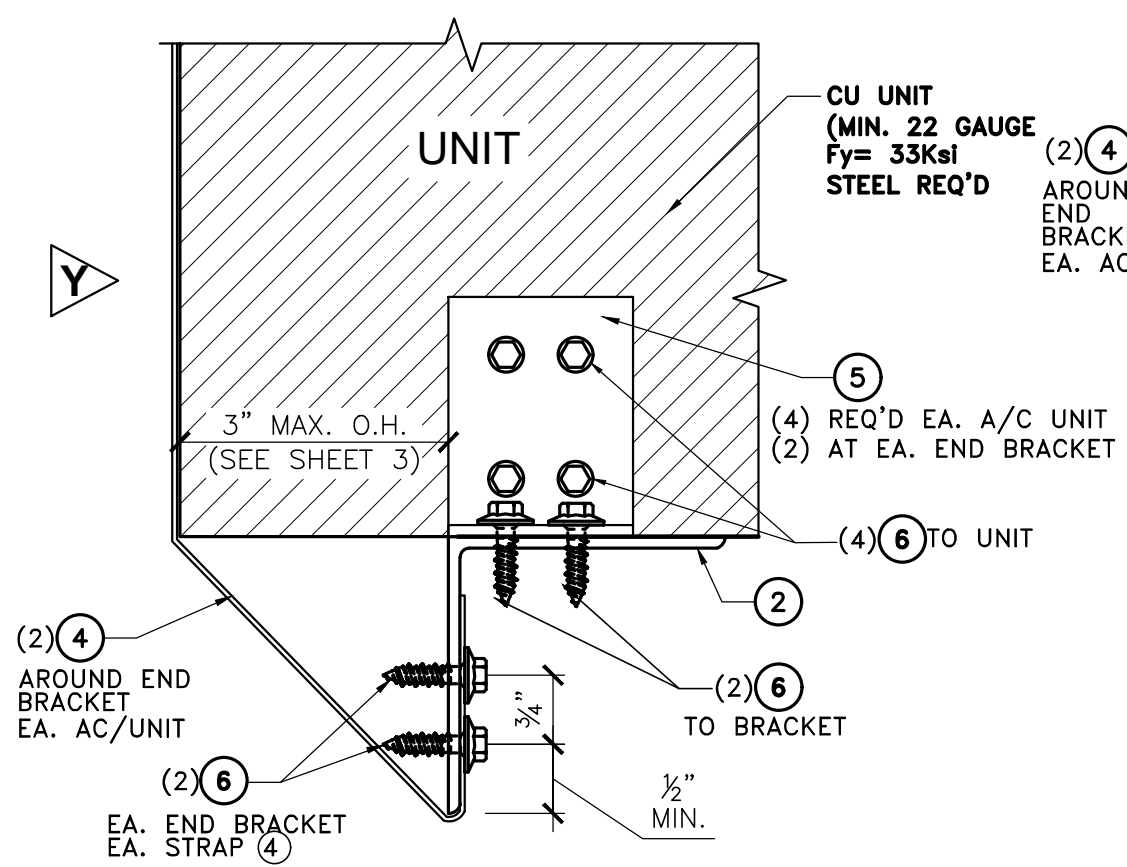

DETAIL 1
(WHEN UNIT OVERHANG)
 1/2" = 0'-1" ELEVATION

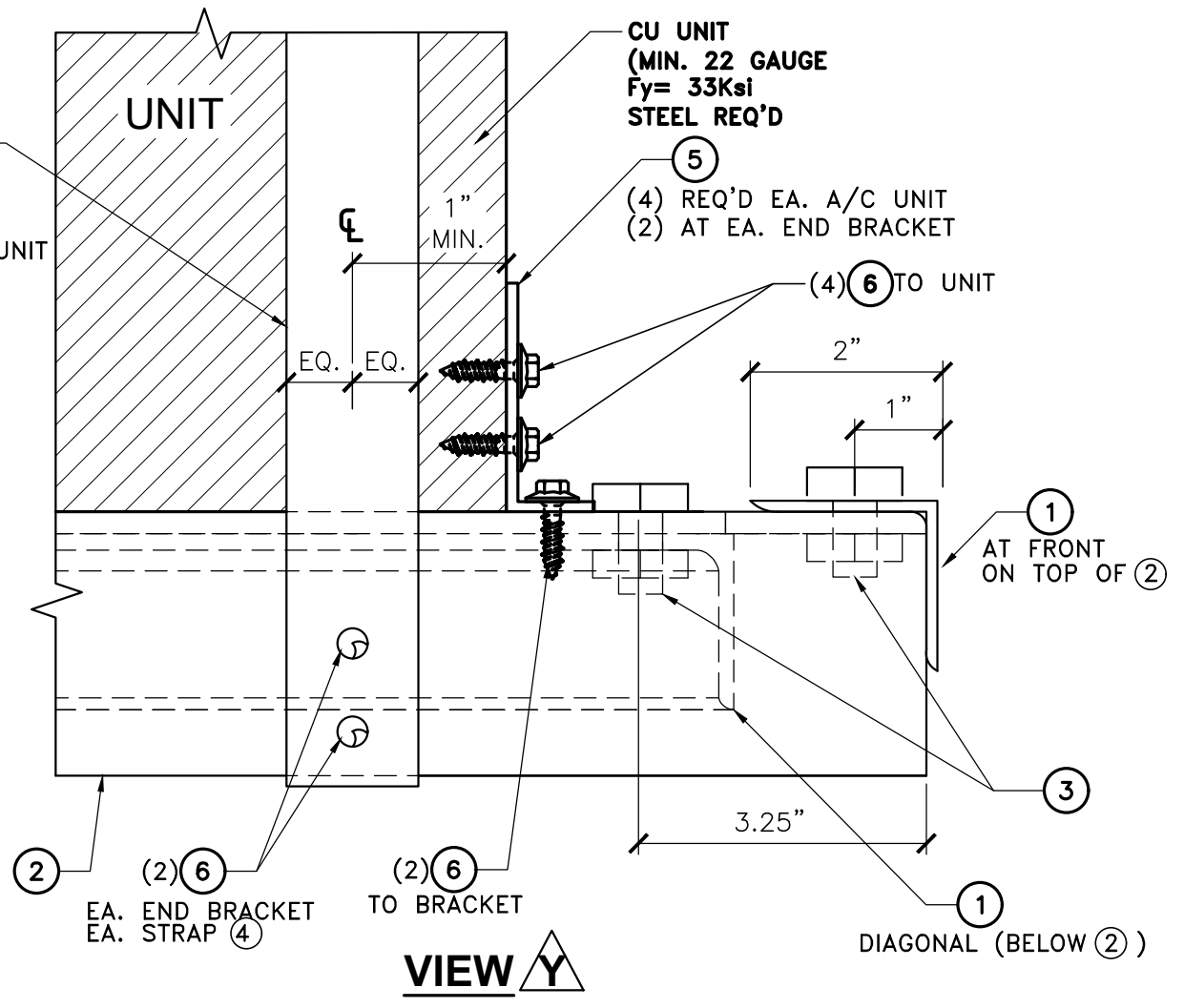

VIEW Y

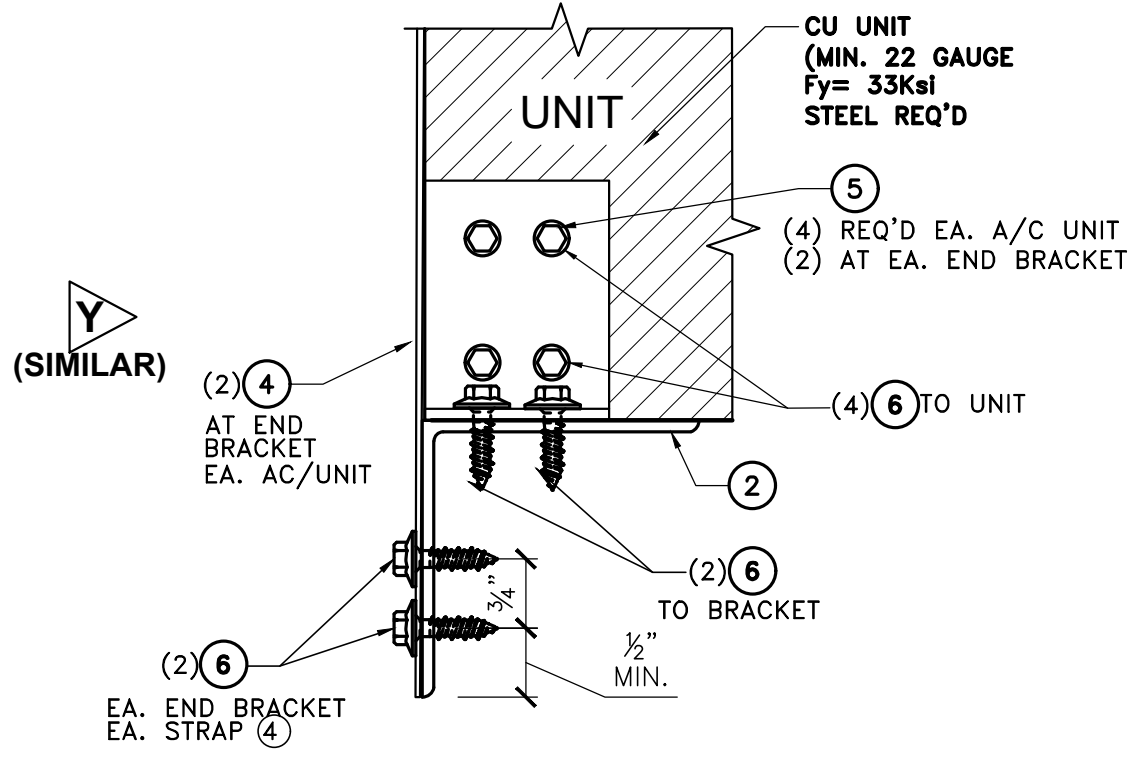

DETAIL 2
(OPTIONAL WHEN UNIT DOES NOT OVERHANG)
 1/2" = 0'-1" ELEVATION

FLORIDA BUILDING CODE (High and Non High Velocity Hurricane Zone)

ALUMINUM WALL MOUNTED BRACKET
STAND FOR AIR CONDITIONING UNIT

F&L ALUMINUM PARTS, INC.
 2087 N. POWERLINE RD. SUITE #1
 POMPANO BEACH, FL. 33069

© 2024 TILTECO INC.



TILTECO INC.
 TILLIT TESTING & ENGINEERING COMPANY
 6355 N.W. 36th St. Ste. 305 VIRGINIA GARDENS, FL 33166
 Phone: (305)871-1530 Fax: (305)871-1531
 e-mail: tilteco@aol.com
 CA-0006719
 WALTER A. TILLIT Jr. P.E.
 FLORIDA Lic. # 44167

REV. NO.	DESCRIPTION	DATE	REV. NO.	DESCRIPTION	DATE
1			3		
2			4		

DRAWN BY: W.H
 01/08/2024
 DATE
23-246
 DRAWING No
 SHEET 5 OF 6

P.E. SEAL/SIGNATURE/DATE

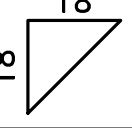
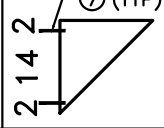
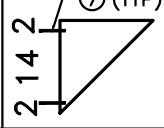
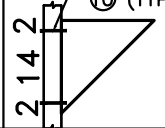
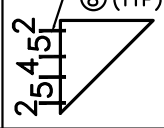
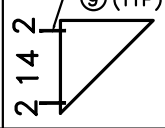
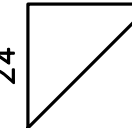
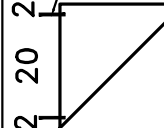
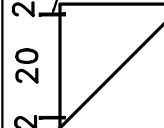
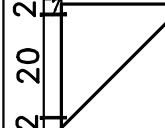
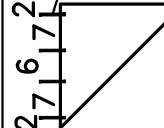
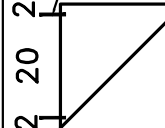
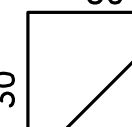
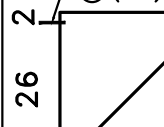
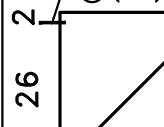
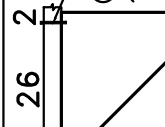
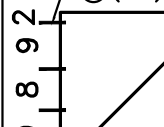
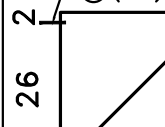
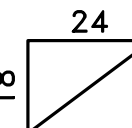
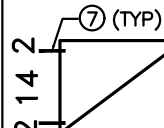
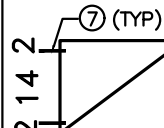
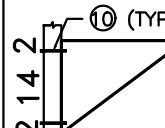
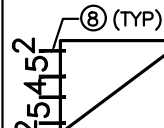
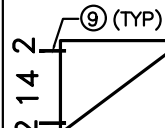
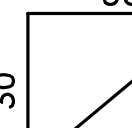
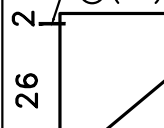
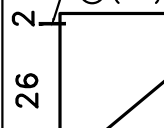
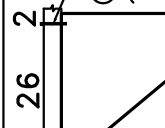
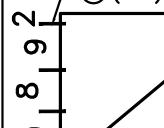
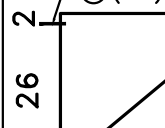
REQUIRED END BRACKETS ANCHORAGE TO EXISTING WALL SUBSTRATE VS BRACKET DIMENSIONS

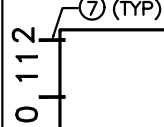
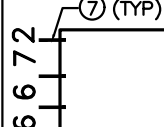
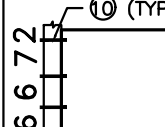
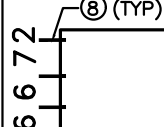
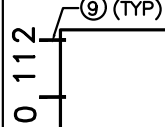
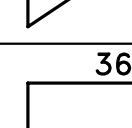
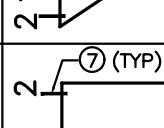
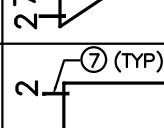
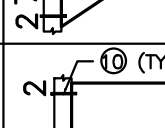
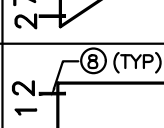
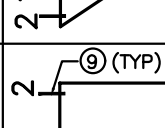
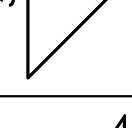
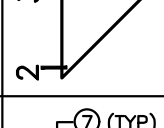
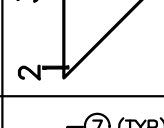
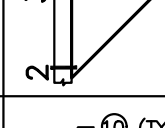
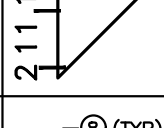
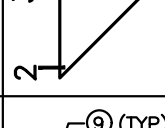
BRACKET DIMENSIONS	END BRACKETS (SEE SHEET 3)				
	POURED CONCRETE	GROUTED CONCRETE BLOCK WALL	HOLLOW CONCRETE BLOCK WALL	WOOD FRAME	STEEL FRAME
18 					
24 					
30 					
18 					
36 					
48 					
36 					
40 					

FLORIDA BUILDING CODE (High and Non High Velocity Hurricane Zone)

**ALUMINUM WALL MOUNTED BRACKET
STAND FOR AIR CONDITIONING UNIT**

F&L ALUMINUM PARTS, INC.
2087 N. POWERLINE RD. SUITE #1
POMPANO BEACH, FL. 33069



TILECO INC.
TILLIT TESTING & ENGINEERING COMPANY
6355 N.W. 36th St. Ste. 305 VIRGINIA GARDENS, FL 33166
Phone: (305)871-1530 Fax: (305)871-1531
e-mail: tileco@aol.com

WALTER A. TILLIT JR. P.E.
FLORIDA Lic. # 44167

P.E. SEAL/SIGNATURE/DATE

DRAWN BY: W.H	DATE	23-246 DRAWING No
01/08/2024		

REV. No	DATE	DESCRIPTION
1		
2		
3		
4		

REQUIRED INTERIOR BRACKETS ANCHORAGE TO EXISTING WALL SUBSTRATE VS BRACKET DIMENSIONS

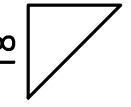
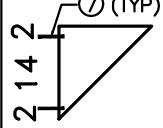
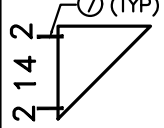
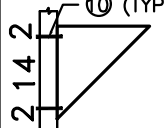
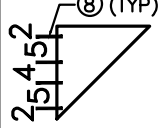
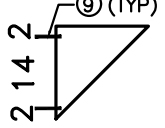
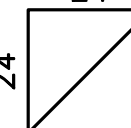
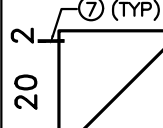
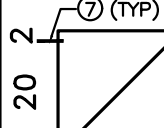
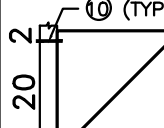
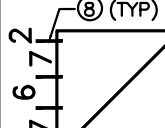
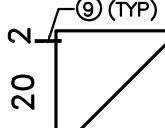
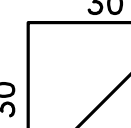
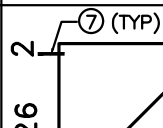
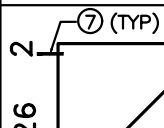
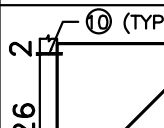
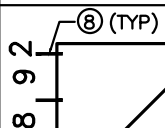
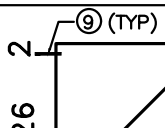
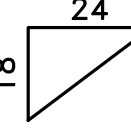
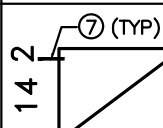
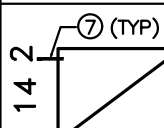
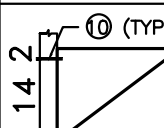
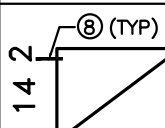
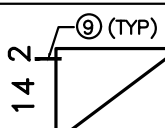
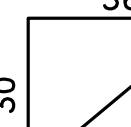
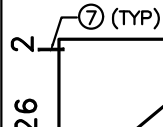
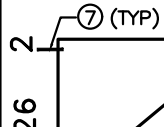
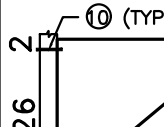
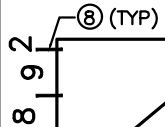
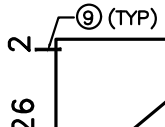
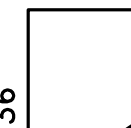
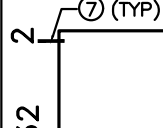
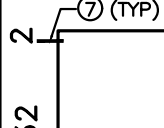
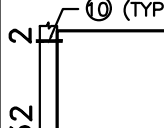
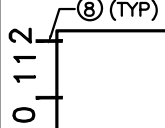
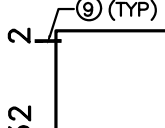
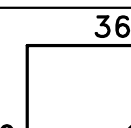
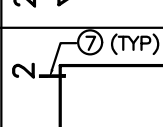
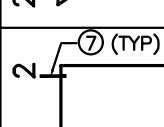
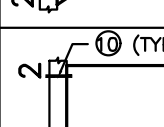
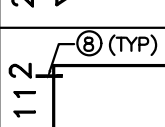
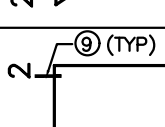
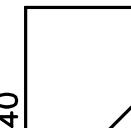
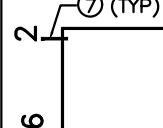
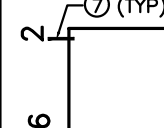
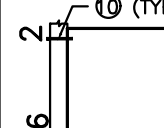
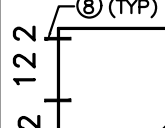
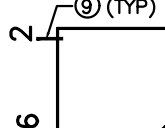
INTERIOR BRACKETS (SEE SHEET 4)					
BRACKET DIMENSIONS	POURED CONCRETE	GROUTED CONCRETE BLOCK WALL	HOLLOW CONCRETE BLOCK WALL	WOOD FRAME	STEEL FRAME
18 	 ⑦ (TYP)	 ⑦ (TYP)	 ⑩ (TYP)	 ⑧ (TYP)	 ⑨ (TYP)
24 	 ⑦ (TYP)	 ⑦ (TYP)	 ⑩ (TYP)	 ⑧ (TYP)	 ⑨ (TYP)
30 	 ⑦ (TYP)	 ⑦ (TYP)	 ⑩ (TYP)	 ⑧ (TYP)	 ⑨ (TYP)
18 24 	 ⑦ (TYP)	 ⑦ (TYP)	 ⑩ (TYP)	 ⑧ (TYP)	 ⑨ (TYP)
30 36 	 ⑦ (TYP)	 ⑦ (TYP)	 ⑩ (TYP)	 ⑧ (TYP)	 ⑨ (TYP)
36 48 	 ⑦ (TYP)	 ⑦ (TYP)	 ⑩ (TYP)	 ⑧ (TYP)	 ⑨ (TYP)
36 36 	 ⑦ (TYP)	 ⑦ (TYP)	 ⑩ (TYP)	 ⑧ (TYP)	 ⑨ (TYP)
40 40 	 ⑦ (TYP)	 ⑦ (TYP)	 ⑩ (TYP)	 ⑧ (TYP)	 ⑨ (TYP)

FLORIDA BUILDING CODE (High and Non High Velocity Hurricane Zone)

**ALUMINUM WALL MOUNTED BRACKET
STAND FOR AIR CONDITIONING UNIT**

F&L ALUMINUM PARTS, INC.
2087 N. POWERLINE RD. SUITE #1
POMPANO BEACH, FL. 33069

© 2024 TILTECO INC.

TILTECO INC.

TILLIT TESTING & ENGINEERING COMPANY
6355 N.W. 36th St. Ste. 305 VIRGINIA GARDENS, FL 33166
Phone : (305)871-1530 . Fax : (305)871-1531
e-mail: tilteco@aol.com
CA-0006719
WALTER A. TILLIT JR. P.E.
FLORIDA Lic. # 44167

DRAWN BY:
W.H
01/08/2024
DATE

23-246
DRAWING No

SHEET 6A OF 6

REV. No	DATE	REV. No	DATE	DESCRIPTION
1	-	3	-	-
2	-	4	-	-

P.E. SEAL/SIGNATURE/DATE